

Thermowells and Bosses

TW, TS, TF, TJ and BS Series



FITOK

Thermowells

TW, TS, TF and TJ Series

Features

- © FITOK thermowells provide reliable heat-transmission performance under high temperature, high pressure, and corrosive conditions.
- © Rugged mechanical construction ensures resistance to distortion under sharp temperature fluctuation conditions.
- © Straight, stepped, and tapered shank designs are available.
- © Standard instrument connection is 1/2 NPT, other connections are available on request.
- © Materials include 316 SS, 304 SS, 321 SS, F91, F92, 316H SS, carbon steel, brass, titanium, alloy C-276 and alloy 400.

Velocity Ratings

When selecting a thermowell, take maximum fluid velocity rating into consideration to avoid failure due to resonance vibration, as well as connection type, insertion length, and bore diameter.

Please refer to the table below for the maximum fluid velocities:

Maximum Fluid Velocities (ft/sec)

Shank Style	Root Dia. in.	Material	Process Fluid	Immersion Length							
				2.5"	4.5"	7.5"	10.5"	13.5"	16.5"	19.5"	22.5"
Stepped	3/4	Brass	Liquid/Gas	59.3/207.0	39.8/89.1	23.9/32.3	16.4	9.9	6.6	4.8	3.6
		Carbon Steel	Liquid/Gas	106.0/290.0	71.2/123.0	42.7/44.9	22.8	13.8	9.3	6.7	4.9
		304 SS, 316 SS	Liquid/Gas	148.0/300.0	99.3/128.0	46.4	23.6	14.3	9.6	6.9	5.1
		Monel	Liquid/Gas	118.0/261.0	79.8/112.0	40.6	20.7	12.4	8.3	6.1	4.5
	7/8	Brass	Liquid/Gas	59.3/207.0	47.6/102.0	37.0/28.0	18.8	11.4	7.6	5.5	4.1
		Carbon Steel	Liquid/Gas	106.0/290.0	84.3/143.0	51.6/50.6	26.2	15.9	10.6	7.6	5.7
		304 SS, 316 SS	Liquid/Gas	148.0/300.0	117.0/148.0	53.5	27.2	16.5	11.0	7.9	5.9
		Monel	Liquid/Gas	118.0/261.0	93.3/128.0	46.7	23.7	14.4	9.5	6.9	5.1
Straight	Any	Brass	Liquid/Gas	145.0/290.0	80.0/150.0	48.0/54.1	27.6	16.7	11.1	8.0	6.0
		Carbon Steel	Liquid/Gas	260.0/326.0	144.0/192.0	69.5	35.4	20.5	14.3	10.3	7.7
		304 SS, 316 SS	Liquid/Gas	360.0/349.0	199.0	71.9	36.6	21.2	14.8	10.7	8.0
		Monel	Liquid/Gas	316.0/320.0	178.0/189.0	68.1	34.8	20.8	14.0	10.0	7.5
Tapered	Any	Carbon Steel	Liquid/Gas	270.0/410.0	150.0/249.0	90.3	45.6	27.8	18.5	13.2	9.8
		304 SS, 316 SS	Liquid/Gas	350.0/483.0	208.0/272.0	97.3	49.7	30.4	20.3	14.5	10.7
		Monel	Liquid/Gas	300.0/396.0	167.0/214.0	77.5	39.2	23.8	16.0	10.3	7.7



TW series

Straight

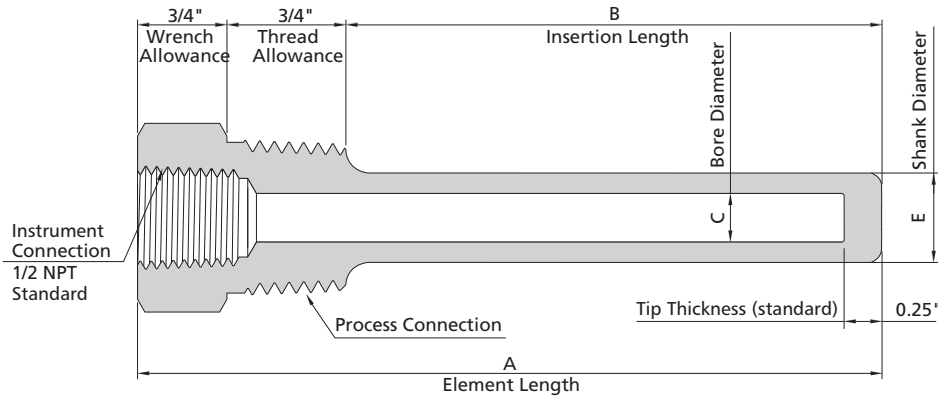

Standard Sizes

Instrument Connection	Process Connection	Dimension, in. (mm)				
		C	E	B	A	
1/2 NPT Standard	3/4 NPT	0.413 (10.5)	0.750 (19.0)	4.5 (114.3)	6 (152.4)	
	1 NPT					
	3/4 NPT	0.656 (16.6)	1.060 (27.0)	7.5 (190.5)	9 (228.6)	
	1 NPT					
	3/4 NPT		0.385 (9.8)	0.750 (19.0)	2.5 (63.5)	4 (101.6)
					4.5 (114.3)	6 (152.4)
					7.5 (190.5)	9 (228.6)
					10.5 (266.7)	12 (304.8)
					13.5 (342.9)	15 (381.0)
					16.5 (419.1)	18 (457.2)
	1 NPT		0.385 (9.8)	0.750 (19.0)	22.5 (571.5)	24 (609.6)
					2.5 (63.5)	4 (101.6)
					4.5 (114.3)	6 (152.4)
					7.5 (190.5)	9 (228.6)
10.5 (266.7)					12 (304.8)	
13.5 (342.9)					15 (381.0)	
16.5 (419.1)					18 (457.2)	
22.5 (571.5)					24 (609.6)	

3 Thermowells and Bosses

Stepped

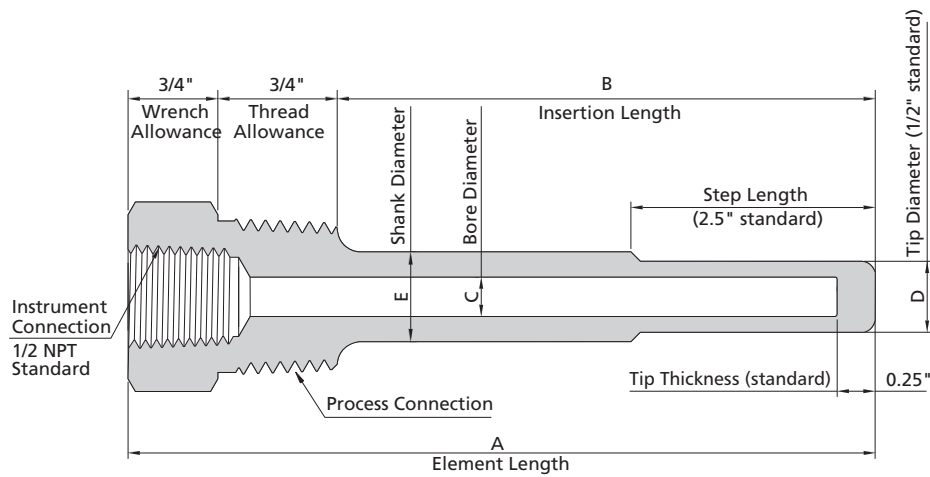

Standard Sizes

Instrument Connection	Process Connection	Dimension, in. (mm)			
		C	E	B	A
1/2 NPT Standard	1/2 NPT	0.260 (6.6)	0.625 (16.0)	2.5 (63.5)	4 (101.6)
				4.5 (114.3)	6 (152.4)
				7.5 (190.5)	9 (228.6)
				10.5 (266.7)	12 (304.8)
				13.5 (342.9)	15 (381.0)
				16.5 (419.1)	18 (457.2)
	3/4 NPT	0.260 (6.6)	0.750 (19.0)	2.5 (63.5)	4 (101.6)
				4.5 (114.3)	6 (152.4)
				7.5 (190.5)	9 (228.6)
				10.5 (266.7)	12 (304.8)
				13.5 (342.9)	15 (381.0)
				16.5 (419.1)	18 (457.2)
	1 NPT	0.260 (6.6)	0.875 (22.3)	2.5 (63.5)	4 (101.6)
				4.5 (114.3)	6 (152.4)
				7.5 (190.5)	9 (228.6)
				10.5 (266.7)	12 (304.8)
				13.5 (342.9)	15 (381.0)
				16.5 (419.1)	18 (457.2)
			22.5 (571.5)	24 (609.6)	

Tapered

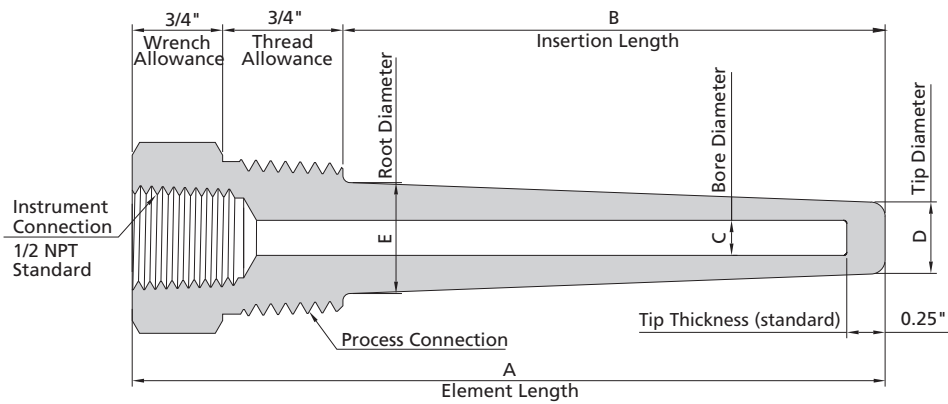

Standard Sizes

Instrument Connection	Process Connection	Dimension, in. (mm)				
		C	E	D	B	A
1/2 NPT Standard	3/4 NPT	0.260 (6.6)	0.875 (22.3)	0.625 (16.0)	2.5 (63.5)	4 (101.6)
					4.5 (114.3)	6 (152.4)
					7.5 (190.5)	9 (228.6)
					10.5 (266.7)	12 (304.8)
					13.5 (342.9)	15 (381.0)
					16.5 (419.1)	18 (457.2)
	1 NPT	0.260 (6.6)	1.060 (27.0)	0.625 (16.0)	2.5 (63.5)	4 (101.6)
					4.5 (114.3)	6 (152.4)
					7.5 (190.5)	9 (228.6)
					10.5 (266.7)	12 (304.8)
					13.5 (342.9)	15 (381.0)
					16.5 (419.1)	18 (457.2)
	3/4 NPT	0.385 (9.8)	0.875 (22.3)	0.750 (19.0)	2.5 (63.5)	4 (101.6)
					4.5 (114.3)	6 (152.4)
					7.5 (190.5)	9 (228.6)
					10.5 (266.7)	12 (304.8)
					13.5 (342.9)	15 (381.0)
					16.5 (419.1)	18 (457.2)
					22.5 (571.5)	24 (609.6)
					1 NPT	0.385 (9.8)
4.5 (114.3)	6 (152.4)					
7.5 (190.5)	9 (228.6)					
10.5 (266.7)	12 (304.8)					
13.5 (342.9)	15 (381.0)					
16.5 (419.1)	18 (457.2)					
22.5 (571.5)	24 (609.6)					

5 Thermowells and Bosses

TS series

Straight

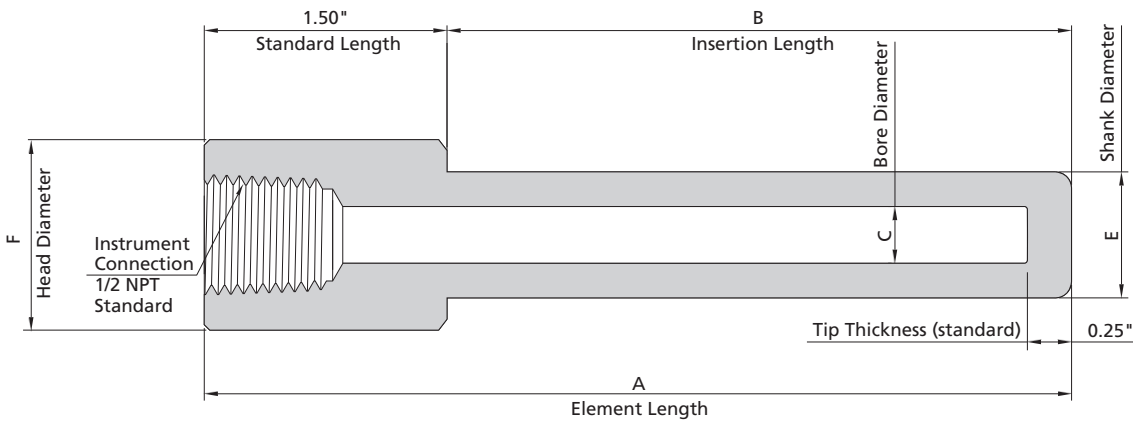

Standard Sizes

Instrument Connection	Dimension, in. (mm)				
	C	E	F	B	A
1/2 NPT Standard	0.260 (6.6)	0.750 (19.0)	1.060 (27.0)	2.5 (63.5)	4 (101.6)
				4.5 (114.3)	6 (152.4)
				7.5 (190.5)	9 (228.6)
				10.5 (266.7)	12 (304.8)
				13.5 (342.9)	15 (381.0)
				16.5 (419.1)	18 (457.2)
	0.260 (6.6)	0.875 (22.3)	1.315 (33.5)	2.5 (63.5)	4 (101.6)
				4.5 (114.3)	6 (152.4)
				7.5 (190.5)	9 (228.6)
				10.5 (266.7)	12 (304.8)
				13.5 (342.9)	15 (381.0)
				16.5 (419.1)	18 (457.2)
22.5 (571.5)	24 (609.6)				

Stepped

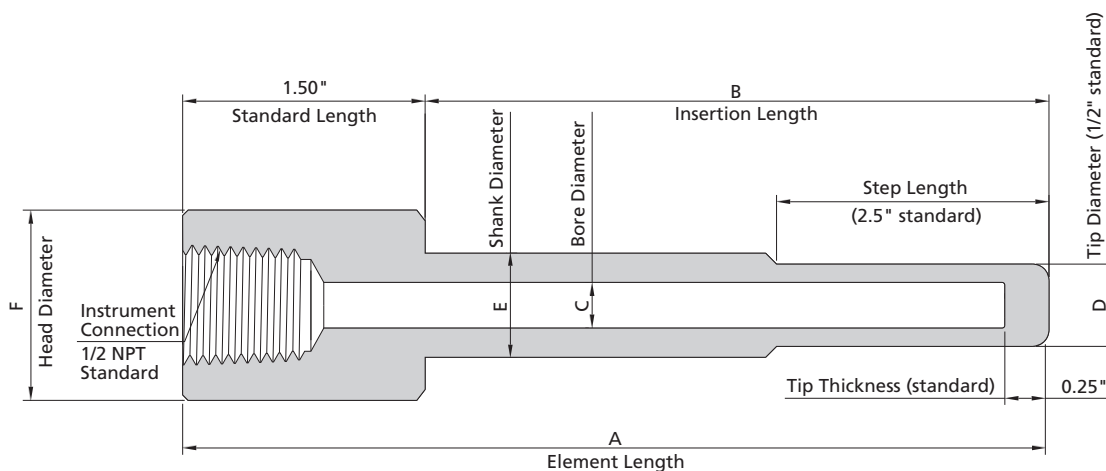

Standard Sizes

Instrument Connection	Dimension, in. (mm)				
	C	E	F	B	A
1/2 NPT Standard	0.260 (6.6)	0.750 (19.0)	1.060 (27.0)	2.5 (63.5)	4 (101.6)
				4.5 (114.3)	6 (152.4)
				7.5 (190.5)	9 (228.6)
				10.5 (266.7)	12 (304.8)
				13.5 (342.9)	15 (381.0)
				16.5 (419.1)	18 (457.2)
				22.5 (571.5)	24 (609.6)
	0.260 (6.6)	0.875 (22.3)	1.315 (33.5)	2.5 (63.5)	4 (101.6)
				4.5 (114.3)	6 (152.4)
				7.5 (190.5)	9 (228.6)
				10.5 (266.7)	12 (304.8)
				13.5 (342.9)	15 (381.0)
				16.5 (419.1)	18 (457.2)
				22.5 (571.5)	24 (609.6)

7 Thermowells and Bosses

Tapered

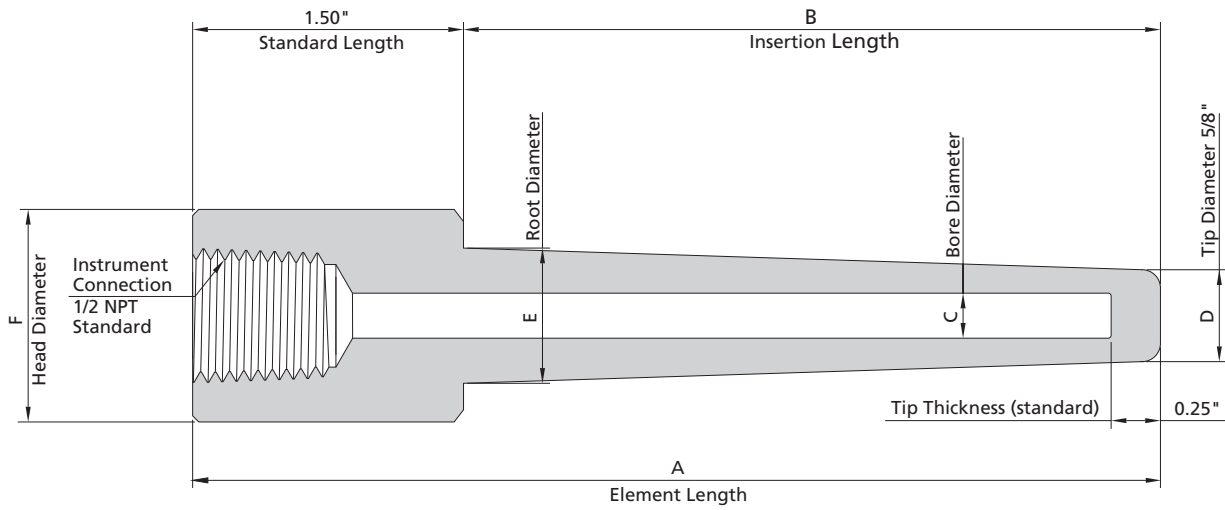

Standard Sizes

Instrument Connection	Dimension, in. (mm)				
	C	E	F	B	A
1/2 NPT Standard	0.260 (6.6)	0.750 (19.0)	1.060 (27.0)	2.5 (63.5)	4 (101.6)
				4.5 (114.3)	6 (152.4)
				7.5 (190.5)	9 (228.6)
				10.5 (266.7)	12 (304.8)
				13.5 (342.9)	15 (381.0)
				16.5 (419.1)	18 (457.2)
				22.5 (571.5)	24 (609.6)
	0.260 (6.6)	1.060 (27.0)	1.315 (33.5)	2.5 (63.5)	4 (101.6)
				4.5 (114.3)	6 (152.4)
				7.5 (190.5)	9 (228.6)
				10.5 (266.7)	12 (304.8)
				13.5 (342.9)	15 (381.0)
				16.5 (419.1)	18 (457.2)
				22.5 (571.5)	24 (609.6)

TF series

Straight

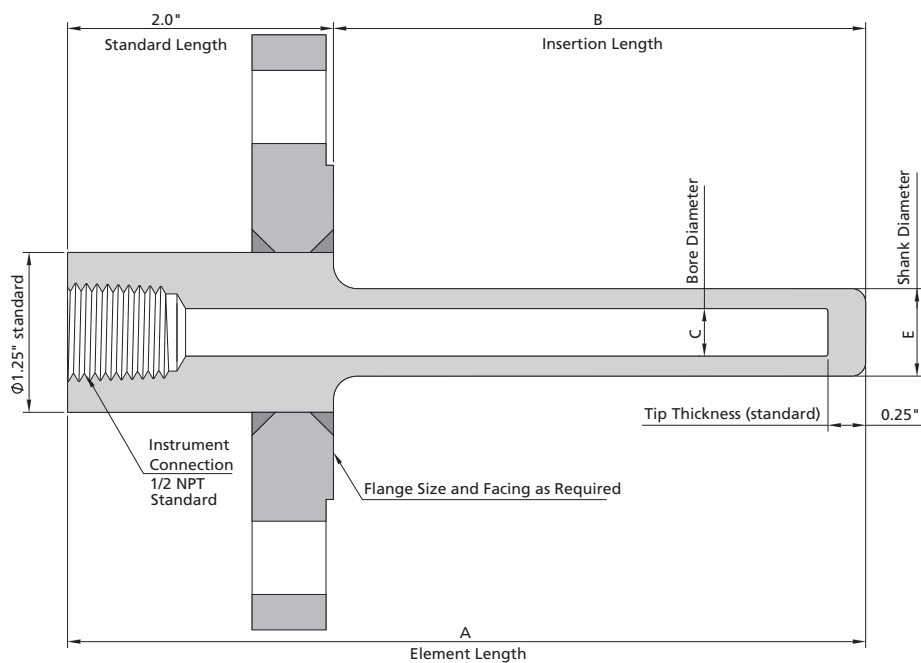

Standard Sizes

Instrument Connection	Process Connection	Dimension, in. (mm)			
		C	E	B	A
1/2 NPT Standard	1 Flange Raised Face ANSI Class 150	0.260 (6.6)	0.750 (19.0)	4 (101.6)	6 (152.4)
				7 (177.8)	9 (228.6)
				10 (254.0)	12 (304.8)
				13 (330.2)	15 (381.0)
				16 (406.4)	18 (457.2)
		0.385 (9.8)	0.875 (22.3)	4 (101.6)	6 (152.4)
				7 (177.8)	9 (228.6)
				10 (254.0)	12 (304.8)
				13 (330.2)	15 (381.0)
				16 (406.4)	18 (457.2)
				22 (558.8)	24 (609.6)

9 Thermowells and Bosses

Stepped

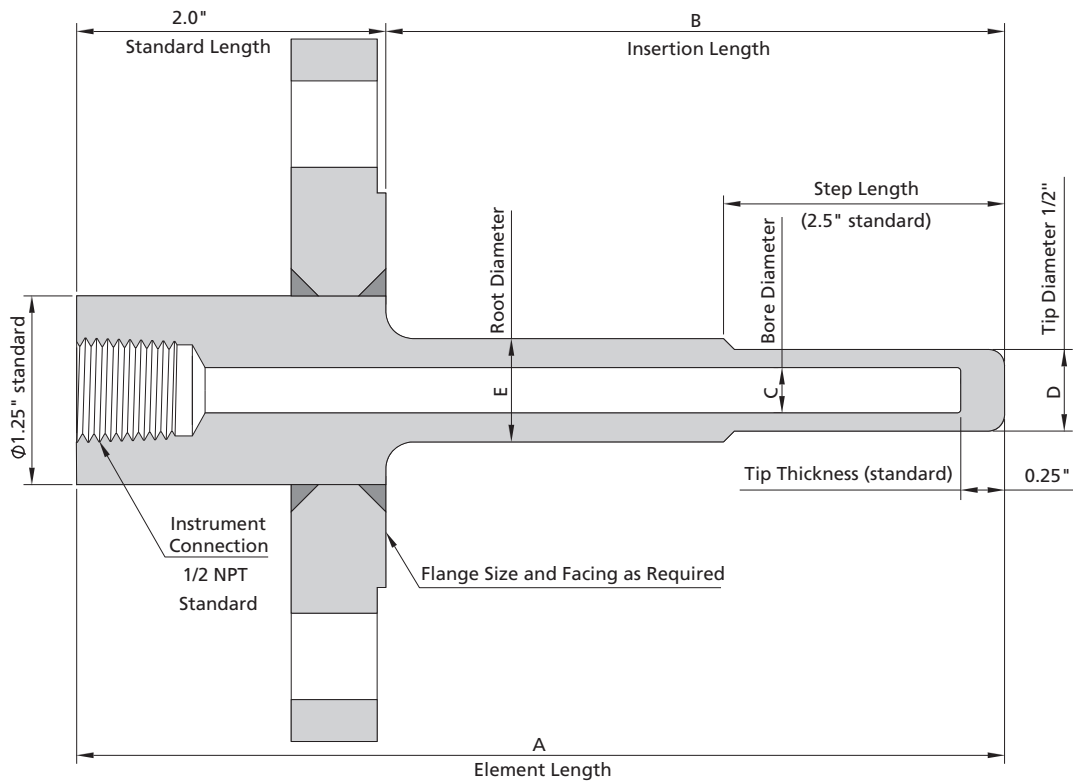

Standard Sizes

Instrument Connection	Process Connection	Dimension, in. (mm)			
		C	E	B	A
1/2 NPT Standard	1 Flange Raised Face ANSI Class 150	0.260 (6.6)	0.750 (19.0)	4 (101.6)	6 (152.4)
				7 (177.8)	9 (228.6)
				10 (254.0)	12 (304.8)
				13 (330.2)	15 (381.0)
				16 (406.4)	18 (457.2)
	1 1/2 Flange Raised Face ANSI Class 150			22 (558.8)	24 (609.6)
				4 (101.6)	6 (152.4)
				7 (177.8)	9 (228.6)
				10 (254.0)	12 (304.8)
				13 (330.2)	15 (381.0)
				16 (406.4)	18 (457.2)
				22 (558.8)	24 (609.6)

Tapered

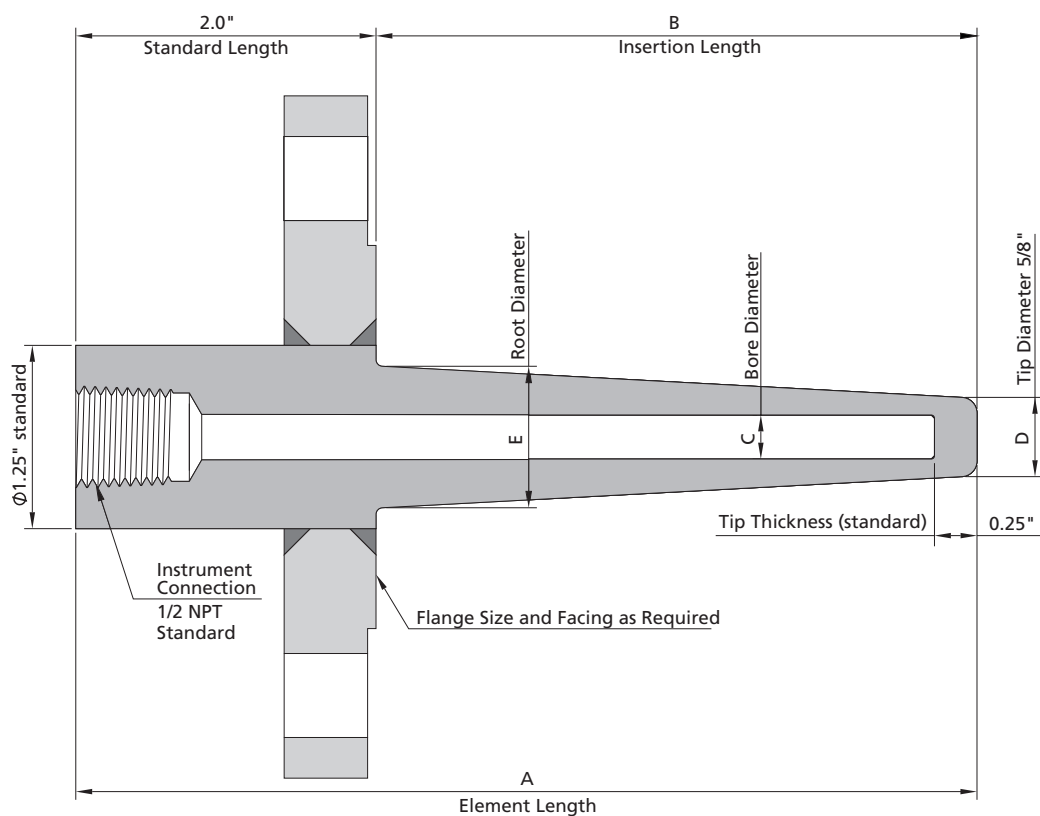

Standard Sizes

Instrument Connection	Process Connection	Dimension, in. (mm)			
		C	E	B	A
1/2 NPT Standard	1 Flange Raised Face ANSI Class 150	0.260 (6.6)	1.060 (27.0)	4 (101.6)	6 (152.4)
				7 (177.8)	9 (228.6)
				10 (254.0)	12 (304.8)
				13 (330.2)	15 (381.0)
				16 (406.4)	18 (457.2)
				22 (558.8)	24 (609.6)
	1 1/2 Flange Raised Face ANSI Class 150			4 (101.6)	6 (152.4)
				7 (177.8)	9 (228.6)
				10 (254.0)	12 (304.8)
				13 (330.2)	15 (381.0)
				16 (406.4)	18 (457.2)
				22 (558.8)	24 (609.6)

11 Thermowells and Bosses

TJ series

Tapered

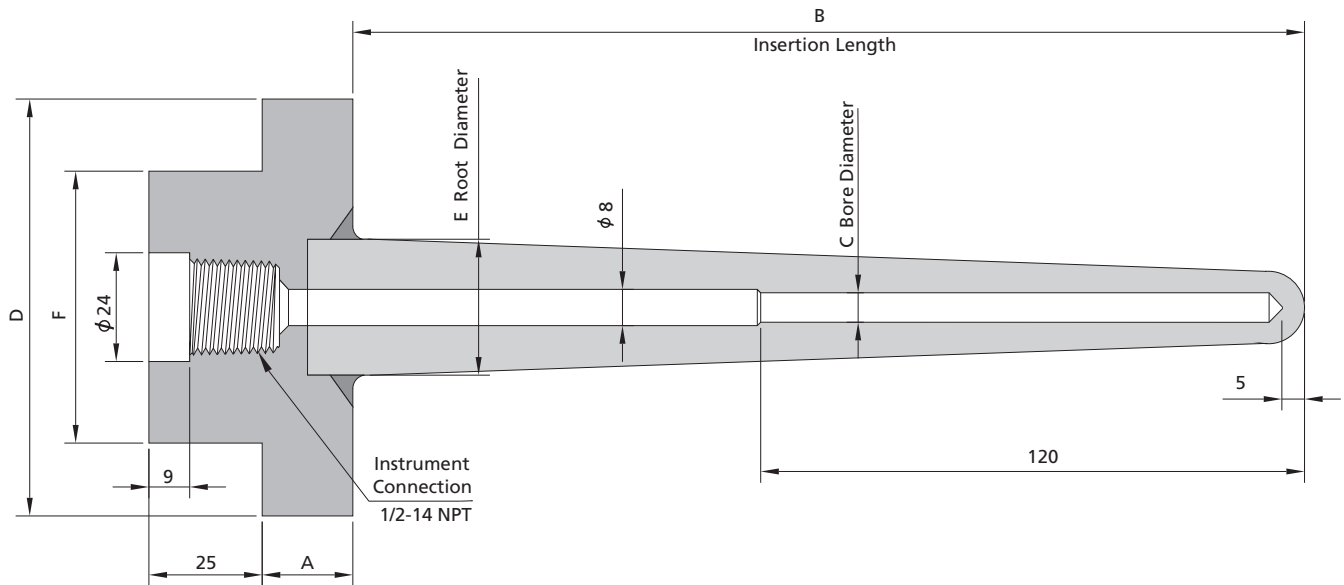

Standard Sizes

Instrument Connection	Process Connection	Dimension, mm						Application Liquid flow rate is less than 8m/s; Gas flow rate is less than 40m/s
		C	E	B	A	D	F	
1/2 NPT Normative	NPS 1 1/2 Flange Raised Face ANSI Class 300	6.5	30	215	15	73	48	Only apply to installation of pipeline
				240				
				290				Only apply to installation of equipment and vessel
				340				
				390				
	440							
	NPS 2 Flange Raised Face ANSI Class 300	6.5	30	160	20	92	60	Only apply to installation of pipeline
Base on Design	Only apply to installation of equipment and vessel							

Part Number Description

SS - TW - FNS8 - RF12150 - ST10 - 6 - 4.5 - SF2

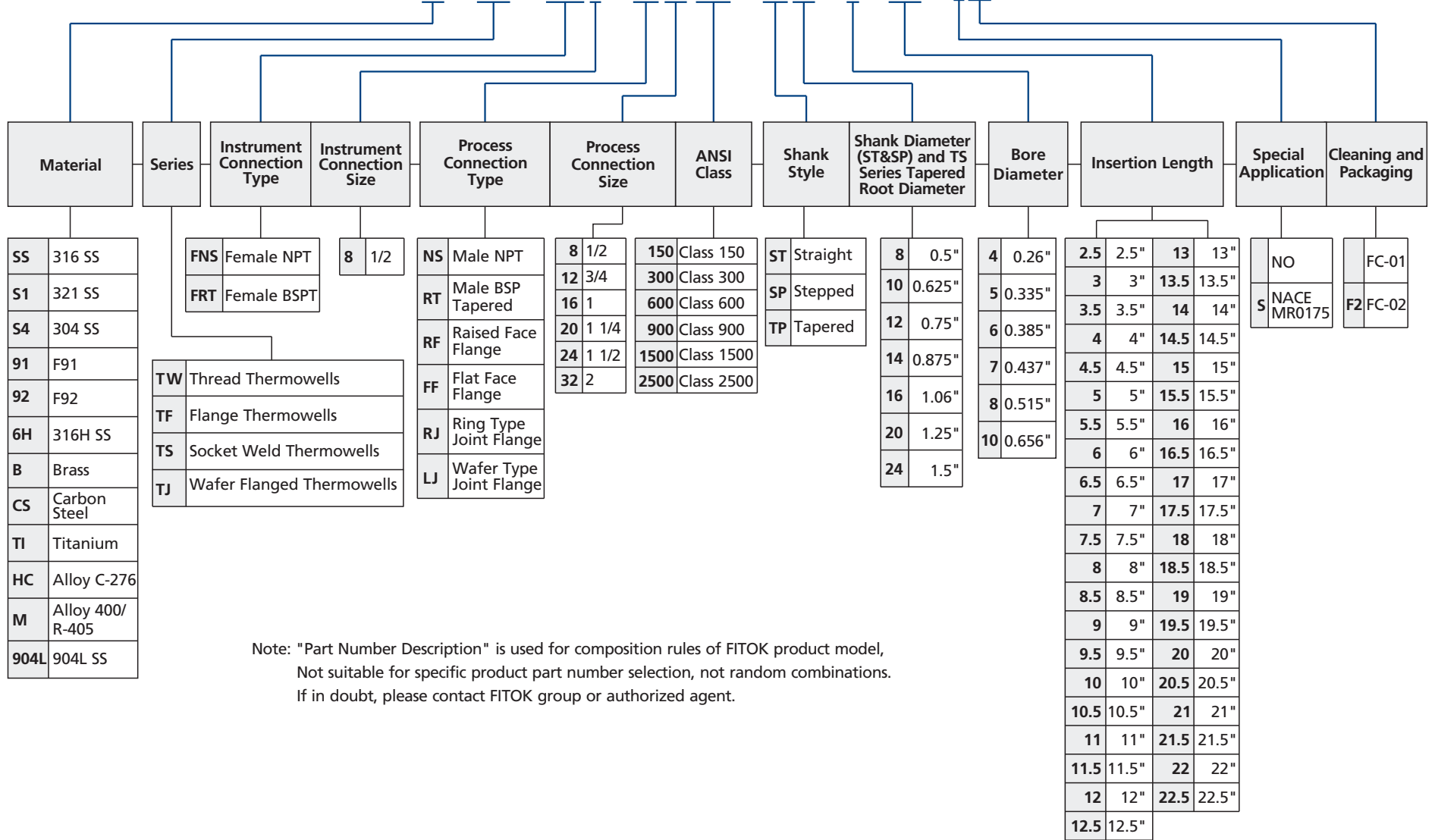

Note: "Part Number Description" is used for composition rules of FITOK product model, Not suitable for specific product part number selection, not random combinations. If in doubt, please contact FITOK group or authorized agent.

13 Thermowells and Bosses

Bosses

BS Series

Features

- Working pressure up to: 1500 psig (104 bar)
- Solid bar stock boss
- Variety of end connections

Dimensions

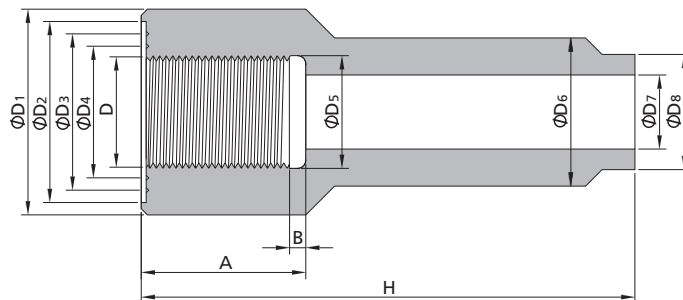

End Connection	Dimensions (mm)											Basic Ordering Number	
	D	ØD ₁	ØD ₂	ØD ₃	ØD ₄	ØD ₅	ØD ₆	ØD ₇	ØD ₈	A	B		H
M12 x 1.5		32	28	23	17	12.3	18	7	12	27	3	60	-BS-FMS12-7-27-60
												120	-BS-FMS12-7-27-120
M16 x 1.5		36	32	27	21	16.3	18	9	14	27	3	60	-BS-FMS16-9-27-60
												120	-BS-FMS16-9-27-120
M27 x 2.0		47	43	38	32	27.4	28	17	22	40	4	60	-BS-FMS27-17-40-60
												120	-BS-FMS27-17-40-120
M33 x 2.0		55	51	44	38	33.4	36	24	30	40	5	60	-BS-FMS33-24-40-60
												120	-BS-FMS33-24-40-120
1/2 Female BSPP		39	35	31	25	21.5	27	16	21	35	4	60	-BS-FRP8-16-35-60
												120	-BS-FRP8-16-35-120
3/4 Female BSPP		47	43	38	32	27.0	31	20	25	40	4	60	-BS-FRP12-20-40-60
												120	-BS-FRP12-20-40-120
1 Female BSPP		55	51	44	38	34.0	41	30	35	45	6	60	-BS-FRP16-30-45-60
												120	-BS-FRP16-30-45-120
M27 x 2.0		47	43			27.4	28	14	22	20	4	(80)	-BS-FMS27-14-20-80
												(140)	-BS-FMS27-14-20-140

- The boss with H in brackets shall be used for the thermometer with movable male thread (such as bimetal therm).
- When the boss is used for bimetal therm, the sealing slot at D₃ and D₄ shall not be processed.
- The boss of M27 x 2 shall be used for TIC or RTD when a=40, used for bimetal therm when a=20.
- The boss with H=120 or 140 shall be used for thermo-insulation objects.
- Dimensions are for reference only and are subject to change.
- Sizes and types listed are standard. Other sizes and types are available on request.
- Materials same as TW series, add the material designator as a prefix to the basic ordering number to get the complete ordering number.

Part Number Description

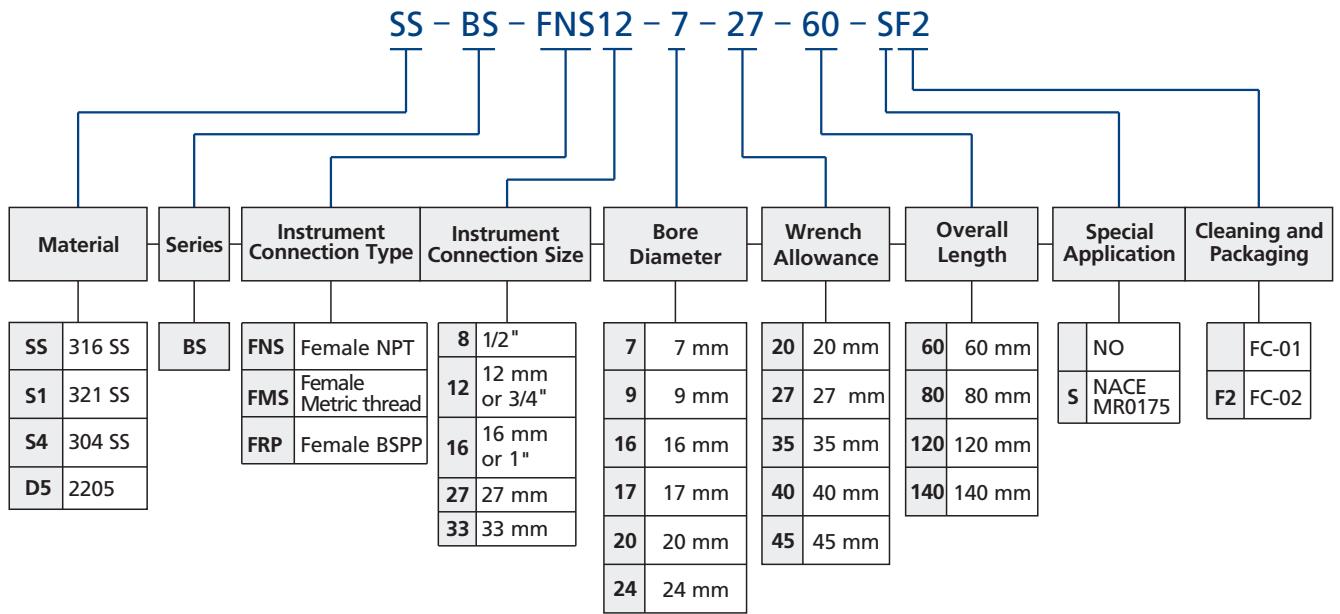

Note: "Part Number Description" is used for composition rules of FITOK product model, Not suitable for specific product part number selection, not random combinations. If in doubt, please contact FITOK group or authorized agent.

info@fitokgroup.com
www.fitokgroup.com

FK-IC-GO-05-EN-150507